

Пластиковые фитинги

Серия E

Для изготовления фитингов используется никелированная бронза (резьбовая часть) и технический пластик (цанговая часть). В качестве уплотнения трубопровода в цанге используется манжета из NBR. Усовершенствованная конструкция цанги позволяет легко извлекать из неё трубопровод. Резьбовое соединение уплотняется кольцом из NBR. Рабочее давление до 9,5 Бар. Могут использоваться с полиэтиленовыми и полиуретановыми трубопроводами. Диапазон рабочих температур фитингов -10 - +60 °С.



SF-EPC-8-G01



SF-EPMF

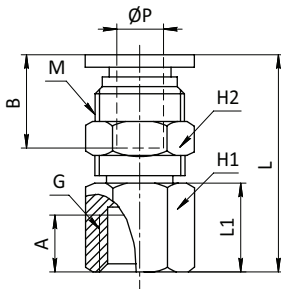

Модель	L	A	B	L1	H1	H2	G	M	ØP
EPMF04-G01	26,2	9	16	11	14	14	G1/8"	M12	4
EPMF04-G02	29,2	12	16	14	17	14	G1/4"	M12	4
EPMF04-G03	30,2	13	16	15	21	14	G3/8"	M12	4
EPMF06-G01	27,1	9	17	9	17	17	G1/8"	M14	6
EPMF06-G02	31,7	12	17	13,5	17	17	G1/4"	M14	6
EPMF06-G03	33,2	13	17	15	19	17	G3/8"	M14	6
EPMF08-G01	31,5	9	18,5	10	19	19	G1/8"	M16	8
EPMF08-G02	35,5	12	18,5	14	19	19	G1/4"	M16	8
EPMF08-G03	36,5	13	18,5	15	19	19	G3/8"	M16	8
EPMF08-G04	40,5	16	18,5	19	24	19	G1/2"	M16	8
EPMF10-G01	31	9	21	11	22	24	G1/8"	M20	10
EPMF10-G02	34	12	21	14	24	24	G1/4"	M20	10
EPMF10-G03	35	13	21	15	24	24	G3/8"	M20	10
EPMF10-G04	39	16	21	19	24	24	G1/2"	M20	10
EPMF12-G01	32,5	9	22,5	10	24	26	G1/8"	M22	12
EPMF12-G02	35,5	12	22,5	13	24	26	G1/4"	M22	12
EPMF12-G03	37,5	13	22,5	15	24	26	G3/8"	M22	12
EPMF12-G04	41,5	16	22,5	19	24	26	G1/2"	M22	12

SF-EPM

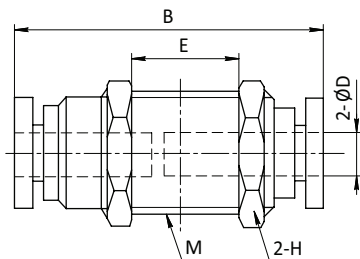

Модель	ØD	M	E	B	H
EPM 4	4	M12	9.7	30.1	14
EPM 6	6	M14	7.5	31.8	17
EPM 8	8	M16	6.8	35.3	19
EPM 10	10	M20	11.5	41.6	24
EPM 12	12	M22	12.8	45.3	27
EPM 16	16	M24	14	50	30

SF-EPLM

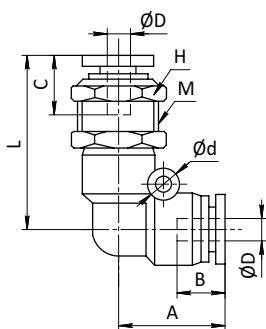

Модель	L	A	B	C	∅D	d	M	H
EPLM 4	43.6	17.5	15.1	14.6	4	3.2	M12	14
EPLM 6	46.5	19	16	15.2	6	3.2	M14	17
EPLM 8	53.3	22.8	18.1	16.2	8	3.2	M16	20
EPLM 10	63.9	27.6	20.4	18.7	10	4.2	M20	24
EPLM 12	69.3	29.6	23.2	21.7	12	4.2	M22	27
EPLM 16	76	33	24.5	24.5	16	5.1	M24	30

SF-EPLF

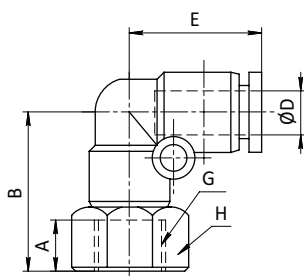

Модель	D	G	A	B	E	H
EPLF04-M5	4	M5	5.5	18.5	17.5	10
EPLF04-G01	4	G1/8"	8	23	17.5	14
EPLF04-G02	4	G1/4"	11	26	17.5	17
EPLF06-M5	6	M5	5	19.7	19	12
EPLF06-G01	6	G1/8"	8	39.1	19	14
EPLF06-G02	6	G1/4"	11	27.4	19	17
EPLF06-G03	6	G3/8"	12	28.7	19	21
EPLF06-G04	6	G1/2"	14	30.9	19	24
EPLF08-G01	8	G1/8"	8	27.3	22.8	14
EPLF08-G02	8	G1/4"	11	30.3	22.8	17
EPLF08-G03	8	G3/8"	12	32	22.8	21
EPLF08-G04	8	G1/2"	14	34.3	22.8	24
EPLF10-G01	10	G1/8"	8	27.3	29.9	17
EPLF10-G02	10	G1/4"	11	34.3	29.9	17
EPLF10-G03	10	G3/8"	12	36.3	29.9	21
EPLF10-G04	10	G1/2"	14	38.8	29.9	24
EPLF12-G02	12	G1/4"	11	37	29.6	21
EPLF12-G03	12	G3/8"	12	38	29.6	21
EPLF12-G04	12	G1/2"	14	40.5	29.6	24
EPLF16-G03	16	G3/8"	11	40.5	33	24
EPLF16-G04	16	G1/2"	13	42.5	33	24

SF-EPLHJ

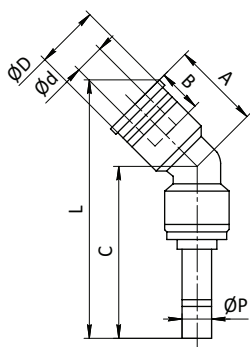

Модель	L	A	B	C	∅D	∅d	∅P
EPLHJ 4	4	47.5	22.7	15.1	16.4	17	4
EPLHJ 6	6	52.5	24.4	16	18	13	6
EPLHJ 8	8	61	27.6	18.1	20.9	14.8	8
EPLHJ 10	10	71.1	30.2	20.4	23.5	18.4	10
EPLHJ 12	12	77.9	33.2	23.2	26.3	21	12

SF-EPLJ

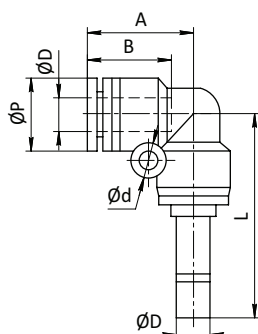

Модель	L	A	B	∅P	∅d	∅D
EPLJ 4	33	17.7	15.1	11	3.2	4
EPLJ 6	36.2	19.3	16	13	3.2	6
EPLJ 8	42.5	22.8	18.1	14.8	3.2	8
EPLJ 10	50.8	27.6	20.4	18.4	4.2	10
EPLJ 12	54.5	29.6	23.2	21	4.2	12
EPLJ 16	59.8	33.5	24.8	24	5.1	16

Пластиковые фитинги

SF-EPYJ

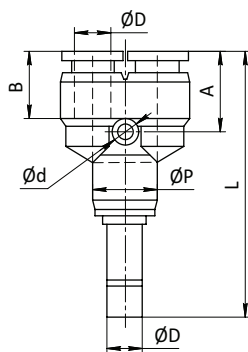

Модель	L	A	B	$\varnothing D$	$\varnothing d$	$\varnothing P$
EPYJ 4	51.2	14.2	15.1	4	3.2	11
EPYJ 6	54.6	15.1	16	6	3.2	13
EPYJ 8	60.1	18.2	18.1	8	3.2	14.8
EPYJ 10	72.9	20.8	20.4	10	4.2	18.4
EPYJ 12	78.1	21.6	23.2	12	4.2	21

SF-EPWJ

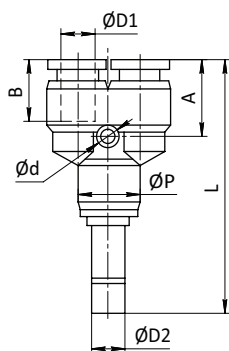

Модель	L	A	B	$\varnothing D1$	$\varnothing D2$	$\varnothing d$	$\varnothing P$
EPWJ6-4	53.7	10	15.1	4	6	3.2	13
EPWJ8-6	60.4	10.5	16	6	8	3.2	14.8
EPWJ10-8	72.3	13.4	18.1	8	10	3.2	18.4
EPWJ12-10	77	15.5	20.4	10	12	4.2	21

SF-EPIJ

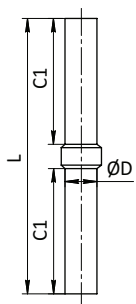

Модель	L	C1	$\varnothing D$
EPIJ4	35	16	4
EPIJ6	36	17	6
EPIJ8	40	18.5	8
EPIJ10	46	21	10
EPIJ12	50	22.5	12
EPIJ16	54	24.8	16

SF-EPIG

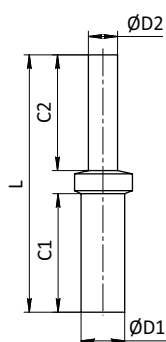

Модель	L	C1	C2	$\varnothing D1$	$\varnothing D2$
EPIG6-4	36	17	16	6	4
EPIG8-4	39.5	18.5	18	8	4
EPIG8-6	38.5	18.5	17	8	6
EPIG10-6	44	22	19	10	6
EPIG10-8	42.5	21	18.5	10	8
EPIG12-8	47	24	20	12	8
EPIG12-10	46.5	22	21	12	10
EPIG16-12	54	24.8	22.5	16	12

SF-EPP

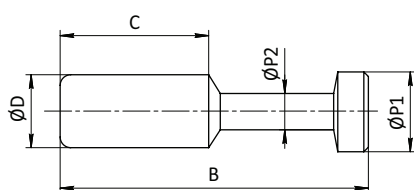

Модель	$\varnothing D$	B	$\varnothing P1$	$\varnothing P2$	C
EPP 4	4	28	5	3	15
EPP 6	6	33	7	3	17
EPP 8	8	37	9	4	18
EPP 10	10	42	11	5	20.5
EPP 12	12	44	13	6	23

SF-EPGJ

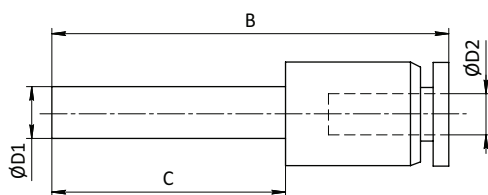

Модель	ØD1	ØD2	B	C
EPGJ 6-4	6	4	42	17
EPGJ 8-4	8	4	44.5	18
EPGJ 8-6	8	6	45	18
EPGJ 10-6	10	6	47	20
EPGJ 10-8	10	8	47	20
EPGJ 12-6	12	6	53.5	23.5
EPGJ 12-8	12	8	54	23.5
EPGJ 12-10	12	10	54.5	23.3

SF-EPU

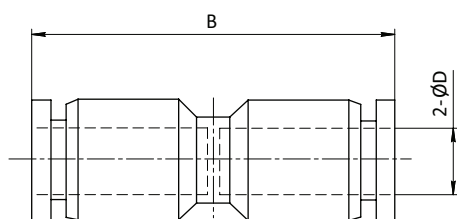

Модель	ØD	B
EPU 4	4	33
EPU 6	6	35.2
EPU 8	8	39.1
EPU 10	10	47.8
EPU 12	12	49.2
EPU 16	16	51

SF-EPG

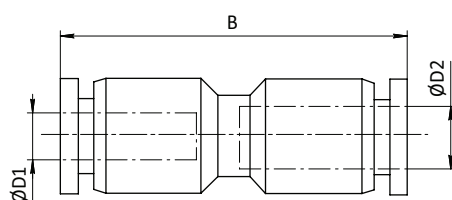

Модель	ØD1	ØD2	B
EPG 6-4	6	4	34.9
EPG 8-6	8	6	38.6
EPG 10-8	10	8	47.3
EPG 12-10	12	10	48.9

SF-EPV

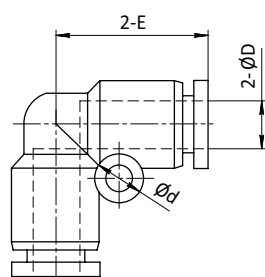

Модель	ØD	Ød	E
EPV 4	4	-	17.5
EPV 6	6	3.2	19
EPV 8	8	3.2	22.8
EPV 10	10	4.2	27.6
EPV 12	12	4.3	29.6
EPV 16	16	5.1	33

SF-EPE

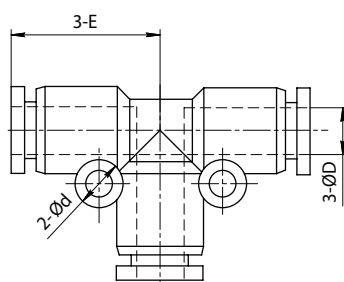

Модель	ØD	Ød	E
EPE 4	4	3.2	18.5
EPE 6	6	3.2	19.3
EPE 8	8	3.2	22.75
EPE 10	10	4.2	28.3
EPE 12	12	4.2	29.6
EPE 16	16	5.1	33

Пластиковые фитинги

SF-EPEG

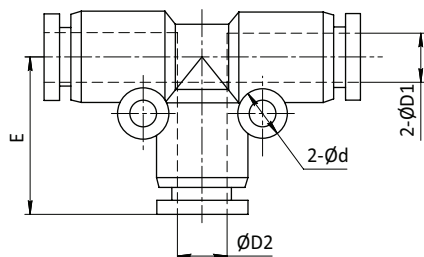

Модель	ØD1	ØD2	2-Ød	E
EPEG 6-4	6	4	3.2	19
EPEG 8-6	8	6	3.2	22.3
EPEG 10-8	10	8	3.2	27.8
EPEG 12-10	12	10	4.2	29.3
EPEG 16-12	16	12	5.1	32.1

SF-EPEW

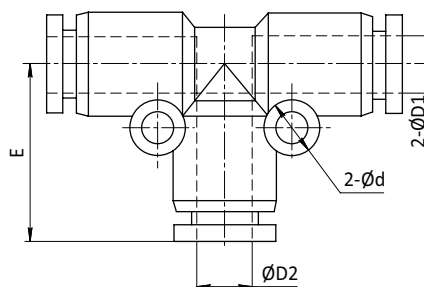

Модель	ØD1	ØD2	Ød	E
EPEW 6-4	4	6	3.2	19.3
EPEW 8-6	6	8	3.2	22.8
EPEW 10-8	8	10	3.2	28.3
EPEW 12-10	10	12	4.2	29.6
EPEW 16-12	12	16	5.1	32.5

SF-EPY

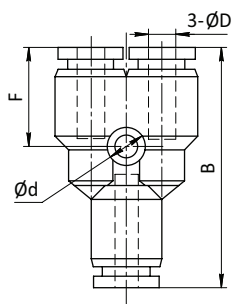

Модель	ØD	Ød	B	F
EPY 4	4	3.2	35.5	14
EPY 6	6	3.2	37.1	14.8
EPY 8	8	3.2	40.4	18.2
EPY 10	10	4.2	49.7	20.8
EPY 12	12	4.2	53.2	21.67
EPY 16	16	5.1	57	24.5

SF-EPW

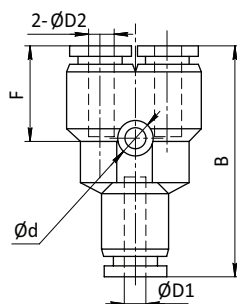

Модель	ØD1	ØD2	Ød	B	F
EPW 6-4	6	4	3.2	36.8	14.5
EPW 8-6	8	6	3.2	39.9	17.7
EPW 10-8	10	8	4.2	49.2	20.3
EPW 12-10	12	10	4.2	52.9	21.3
EPW 16-12	16	12	5.1	62	24.5

SF-EPZA

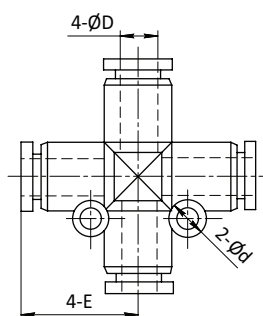

Модель	ØD	Ød	E
EPZA 4	4	3.2	17.5
EPZA 6	6	3.2	19.3
EPZA 8	8	3.2	22.75
EPZA 10	10	4.2	28.3
EPZA 12	12	4.3	29.6

SF-EPK

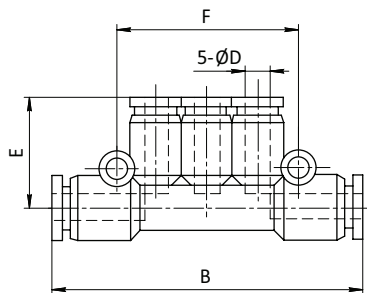

Модель	∅D	F	E	B
EPK 4	4	36	19	57
EPK 6	6	42	20.3	61
EPK 8	8	48	24.3	81.6

SF-EPKG

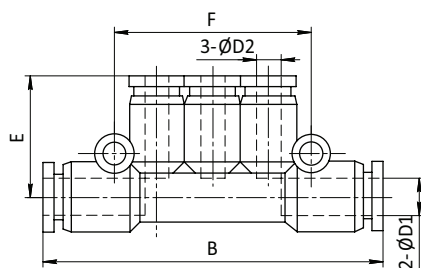

Модель	∅D1	∅D2	F	E	B
EPKG 6-4	6	4	19	36	57.6
EPKG 8-4	8	4	20	42	62.6
EPKG 8-6	8	6	20.3	42	62.6
EPKG 10-6	10	6	23.8	48	77.3
EPKG 10-8	10	8	24.3	48	77.3

SF-EPC-G

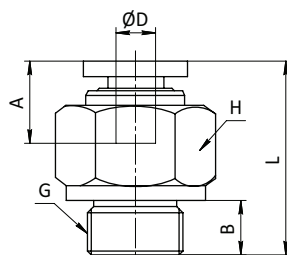

Модель	L	A	B	∅D	G	H	Ключ
EPC 4-M5	18	14.6	4	4	M5	12	3
EPC 4-G01	19.5	14.6	5.5	4	G1/8"	14	3
EPC 4-G02	18.1	14.6	7.5	4	G1/4"	17	3
EPC 6-M5	20.5	15.2	4	6	M5	12	4
EPC 6-G01	20.4	15.2	5.5	6	G1/8"	14	4
EPC 6-G02	22.1	15.2	7.5	6	G1/4"	17	4
EPC 6-G03	20.7	15.2	8.5	6	G3/8"	20	4
EPC 6-G04	24.7	15.2	11	6	G1/2"	24	4
EPC 8-G01	25.1	16.2	5.5	8	G1/8"	14	5
EPC 8-G02	23.5	16.2	7.5	8	G1/4"	17	5
EPC 8-G03	21.1	16.2	8.5	8	G3/8"	20	6
EPC 8-G04	25.1	16.2	11	8	G1/2"	24	6
EPC 10-G01	27.4	18.7	5.5	10	G1/8"	17	5
EPC 10-G02	29.3	16.2	7.5	10	G1/4"	17	6
EPC 10-G03	26.8	16.2	8.5	10	G3/8"	20	8
EPC 10-G04	25.1	16.2	11	10	G1/2"	24	8
EPC 12-G01	30.6	21.7	5.5	12	G1/8"	21	5
EPC 12-G02	32.6	21.7	7.5	12	G1/4"	21	6
EPC 12-G03	29.6	21.7	8.5	12	G3/8"	21	8
EPC 12-G04	30.6	21.7	11	12	G1/2"	24	8
EPC 16-G03	37.5	24.5	8.5	16	G3/8"	24	8
EPC 16-G04	40	24.5	11	16	G1/2"	24	10

Пластиковые фитинги

SF-EPOC-G

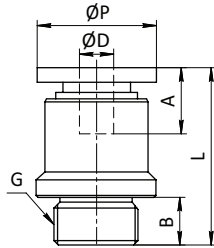

Модель	L	A	B	ØD	G	ØP	Ключ
EPOC 4-G01	19.5	14.6	5.5	4	G1/8"	14	3
EPOC 4-G02	18.1	14.6	7.5	4	G1/4"	17	3
EPOC 6-G01	20.6	15.2	5.5	6	G1/8"	14	4
EPOC 6-G02	22.1	15.2	7.5	6	G1/4"	17	4
EPOC 6-G03	23.1	15.2	8.5	6	G3/8"	21	4
EPOC 8-G01	25.1	16.2	5.5	8	G1/8"	14	5
EPOC 8-G02	23.5	16.2	7.5	8	G1/4"	17	5
EPOC 8-G03	21.1	16.2	8.5	8	G3/8"	20	6
EPOC 8-G04	24.1	16.2	11	8	G1/2"	24	6
EPOC 10-G01	29.9	18.7	5.5	10	G1/8"	14	5
EPOC 10-G02	29.3	18.7	7.5	10	G1/8"	17	6
EPOC 10-G03	26.8	18.7	8.5	10	G3/8"	20	8
EPOC 10-G04	25.1	18.7	11	10	G1/2"	24	8
EPOC 12-G01	34.5	21.7	5.5	12	G1/8"	21	5
EPOC 12-G02	35.4	21.7	7.5	12	G1/4"	21	6
EPOC 12-G03	29.6	21.7	8.5	12	G3/8"	21	8
EPOC 12-G04	32.6	21.7	11	12	G1/2"	24	8
EPOC 16-G03	37.5	24.5	8.5	16	G3/8"	24	8
EPOC 16-G04	38.4	24.5	11	16	G1/2"	24	10

SF-EPCF-G

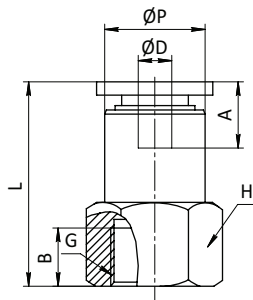

Модель	L	A	B	ØP	ØD	G	H
EPCF 4-G01	23.5	14.6	7	10	4	G1/8"	14
EPCF 4-G02	26.5	14.6	10	10	4	G1/4"	17
EPCF 6-G01	24.4	15.2	7	12	6	G1/8"	14
EPCF 6-G02	27.4	15.2	10	12	6	G1/4"	17
EPCF 6-G03	28.4	15.2	11	12	6	G3/8"	21
EPCF 6-G04	30.4	15.2	13	12	6	G1/2"	24
EPCF 8-G01	25.1	16.2	7	14	8	G1/8"	14
EPCF 8-G02	28.1	16.2	10	14	8	G1/4"	17
EPCF 8-G03	29.1	16.2	11	14	8	G3/8"	21
EPCF 8-G04	31.1	16.2	13	14	8	G1/2"	24
EPCF 10-G01	27.5	18.7	7	17	10	G1/8"	17
EPCF 10-G02	30.5	18.7	10	17	10	G1/4"	17
EPCF 10-G03	31.5	18.7	11	17	10	G3/8"	21
EPCF 10-G04	33.5	18.7	13	17	10	G1/2"	24
EPCF 12-G01	30.6	21.7	7	20	12	G1/8"	21
EPCF 12-G02	33.6	21.7	10	20	12	G1/4"	21
EPCF 12-G03	34.6	21.7	11	20	12	G3/8"	21
EPCF 12-G04	36.6	21.7	13	20	12	G1/2"	24
EPCF 16-G03	38.5	24.5	11	23.8	16	G3/8"	24
EPCF 16-G04	40.5	24.5	13	23.8	16	G1/2"	24

SF-EPLH-G

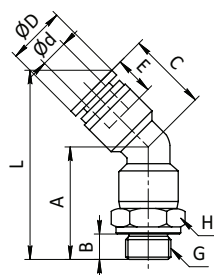

Модель	L	A	B	C	E	ØD	Ød	H	G
EPLH 4-G01	39	22.7	7.5	16.4	15.1	11	4	14	G1/8"
EPLH 4-G02	41.5	25.7	9.5	16.4	15.1	11	4	17	G1/4"
EPLH 6-G01	42	24.4	7.5	18	16	13	6	14	G1/8"
EPLH 6-G02	44.5	26.9	9.5	18	16	13	6	17	G1/4"
EPLH 6-G03	46	28.4	10.5	18	16	13	6	20	G3/8"
EPLH 6-G04	50	31.9	13.5	18	16	13	6	24	G1/2"
EPLH 8-G01	47.5	27.6	7.5	20.9	18.1	14.8	8	14	G1/8"
EPLH 8-G02	50	29.6	9.5	20.9	18.1	14.8	8	17	G1/4"
EPLH 8-G03	51.5	31.1	10.5	20.9	18.1	14.8	8	20	G3/8"
EPLH 8-G04	55.5	34.6	13.5	20.9	18.1	14.8	8	24	G1/2"
EPLH 10-G01	53.1	30.2	7.5	23.5	20.4	18.4	10	17	G1/8"
EPLH 10-G02	55.1	32.2	9.5	23.5	20.4	18.4	10	17	G1/4"
EPLH 10-G03	56.6	33.2	10.5	23.5	20.4	18.4	10	20	G3/8"
EPLH 10-G04	60.6	36.7	13.5	23.5	20.4	18.4	10	24	G1/2"
EPLH 12-G01	59.4	33.2	7.5	26.3	23.2	21	12	21	G1/8"
EPLH 12-G02	61.4	35.2	9.5	26.3	23.2	21	12	21	G1/4"
EPLH 12-G03	62.4	36.2	10.5	26.3	23.2	21	12	21	G3/8"
EPLH 12-G04	66.4	39.2	13.5	26.3	23.2	21	12	24	G1/2"

SF-EPL-G

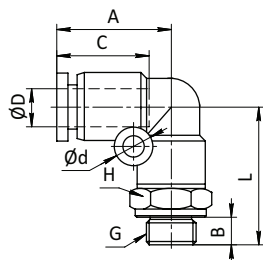

Модель	L	A	B	C	Ød	ØD	H	G
EPL 4-M5	17	17.7	4	15.1	3.2	4	8	M5
EPL 4-G01	24.5	17.7	5.5	15.1	3.2	4	14	G1/8"
EPL 4-G02	27	17.7	7.5	15.1	3.2	4	17	G1/4"
EPL 6-M5	25	19.3	5	16	3.2	6	12	M5
EPL 6-G01	25.7	19.3	5.5	16	3.2	6	14	G1/8"
EPL 6-G02	28.2	19.3	7.5	16	3.2	6	17	G1/4"
EPL 6-G03	29.7	19.3	8.5	16	3.2	6	20	G3/8"
EPL 6-G04	33.7	19.3	11	16	3.2	6	24	G1/2"
EPL 8-G01	29	22.8	5.5	18.1	3.2	8	14	G1/8"
EPL 8-G02	31.5	22.8	7.5	18.1	3.2	8	17	G1/4"
EPL 8-G03	33	22.8	8.5	18.1	3.2	8	20	G3/8"
EPL 8-G04	37	22.8	11	18.1	3.2	8	24	G1/2"
EPL 10-G01	33.8	27.6	5.5	20.4	4.2	10	17	G1/8"
EPL 10-G02	35.8	27.6	7.5	20.4	4.2	10	17	G1/4"
EPL 10-G03	37.3	27.6	8.5	20.4	4.2	10	20	G3/8"
EPL 10-G04	41.3	27.6	11	20.4	4.2	10	24	G1/2"
EPL 12-G01	36	29.6	5.5	23.2	4.2	12	21	G1/8"
EPL 12-G02	38	29.6	7.5	23.2	4.2	12	21	G1/4"
EPL 12-G03	39	29.6	8.5	23.2	4.2	12	21	G3/8"
EPL 12-G04	43	29.6	11	23.2	4.2	12	24	G1/2"
EPL 16-G03	41.5	33	8.5	24.5	5.1	16	24	G3/8"
EPL 16-G04	45.5	33	11	24.5	5.1	16	24	G1/2"

SF-EPLL-G

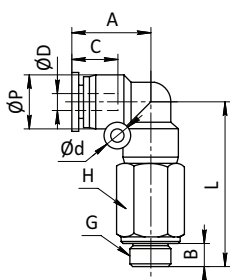

Модель	L	A	B	C	ØP	ØD	H	G	Ød
EPLL 4-G01	35.5	17.7	5.5	15.1	11	4	14	G1/8"	3.2
EPLL 4-G02	39	17.7	7.5	15.1	11	4	17	G1/4"	3.2
EPLL 6-G01	39.2	19.3	5.5	16	13	6	14	G1/8"	3.2
EPLL 6-G02	40.2	19.3	7.5	16	13	6	17	G1/4"	3.2
EPLL 6-G03	43.7	19.3	8.5	16	13	6	20	G3/8"	3.2
EPLL 6-G04	46.2	19.3	11	16	13	6	24	G1/2"	3.2
EPLL 8-G01	44.3	22.8	5.5	18.1	14.8	8	14	G1/8"	3.2
EPLL 8-G02	46.8	22.8	7.5	18.1	14.8	8	17	G1/4"	3.2
EPLL 8-G03	48.4	22.8	8.5	18.1	14.8	8	20	G3/8"	3.2
EPLL 8-G04	50.8	22.8	11	18.1	14.8	8	24	G1/2"	3.2
EPLL 10-G01	54.3	27.6	5.5	20.4	18.4	10	17	G1/8"	4.2
EPLL 10-G02	56.3	27.6	7.5	20.4	18.4	10	17	G1/4"	4.2
EPLL 10-G03	57.3	27.6	8.5	20.4	18.4	10	20	G3/8"	4.2
EPLL 10-G04	60.8	27.6	11	20.4	18.4	10	24	G1/2"	4.2
EPLL 12-G01	60.5	29.6	5.5	23.2	21	12	17	G1/8"	4.2
EPLL 12-G02	61.5	29.6	7.5	23.2	21	12	21	G1/4"	4.2
EPLL 12-G03	62.5	29.6	8.5	23.2	21	12	21	G3/8"	4.2
EPLL 12-G04	65.5	29.6	11	23.2	21	12	24	G1/2"	4.2
EPLL 16-G03	73.5	33	8.5	24.5	25.6	16	24	G3/8"	5.1
EPLL 16-G04	77.5	33	11	24.5	25.6	16	24	G1/2"	5.1

Пластиковые фитинги

SF-EPH-G

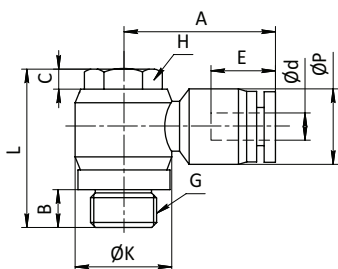

Модель	L	A	B	C	E	P	K	d	G	H
EPH 4-G01	23.5	22.5	5.7	3	15.1	11	14.4	4	G1/8"	14
EPH 4-G02	27	23.6	8.3	4	15.1	11	18.3	4	G1/4"	14
EPH 6-G01	23.5	23.4	5.7	3	16	13	14.4	6	G1/8"	14
EPH 6-G02	27	25.5	8.3	4	16	13	18.3	6	G1/4"	17
EPH 6-G03	32.7	28.5	13.9	4.5	16	13	22	6	G3/8"	21
EPH 6-G04	38.1	30.3	11	5	16	13	28	6	G1/2"	24
EPH 8-G01	23.5	25.6	5.7	3	18.1	14.8	14.4	8	G1/8"	14
EPH 8-G02	27	28.7	8.3	4	18.1	14.8	18.3	8	G1/4"	17
EPH 8-G03	32.7	29.6	13.9	4.5	18.1	14.8	22	8	G3/8"	21
EPH 8-G04	38.1	32.6	11	5.5	18.1	14.8	28	8	G1/2"	24
EPH 10-G01	23.5	30.1	5.7	3	20.4	18.4	14.4	10	G1/8"	17
EPH 10-G02	27	33.1	8.3	4	20.4	18.4	18.3	10	G1/4"	17
EPH 10-G03	32.7	32.9	13.9	4.5	20.4	18.4	22	10	G3/8"	21
EPH 10-G04	38.1	35.9	11	5.5	20.4	18.4	28	10	G1/2"	24
EPH 12-G01	23.5	32.5	5.7	3	23.2	21	14.4	12	G1/8"	21
EPH 12-G02	27	33.5	8.3	4	23.2	21	18.3	12	G1/4"	21
EPH 12-G03	32.7	35.6	13.9	4.5	23.2	21	22	12	G3/8"	21
EPH 12-G04	38.1	36.6	11	5.5	23.2	21	28	12	G1/2"	24

SF-EPHF-G

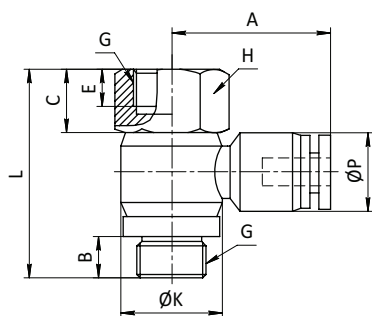

Модель	L	A	B	C	E	ØP	ØK	G	H
EPHF 4-G01	29.5	22.5	5.7	9	7	11	14.4	G1/8"	14
EPHF 4-G02	35	23.6	8.3	12	10	11	18.3	G1/4"	17
EPHF 6-G01	29.5	23.4	5.7	9	7	13	14.4	G1/8"	14
EPHF 6-G02	35	25.5	8.3	12	10	13	18.3	G1/4"	17
EPHF 6-G03	41.2	28.5	13.9	13	11	13	22	G3/8"	21
EPHF 6-G04	47	30.3	11	14.4	13	13	28	G1/2"	24
EPHF 8-G01	29.5	25.6	5.7	9	7	14.8	14.4	G1/8"	14
EPHF 8-G02	35	28.7	8.3	12	10	14.8	18.3	G1/4"	17
EPHF 8-G03	41.2	29.6	13.9	13	11	14.8	22	G3/8"	21
EPHF 8-G04	47	32.6	11	14.4	13	14.8	28	G1/2"	24
EPHF 10-G01	29.5	30.1	5.7	9	7	18.4	14.4	G1/8"	17
EPHF 10-G02	35	33.1	8.3	12	10	18.4	18.3	G1/4"	17
EPHF 10-G03	41.2	32.9	13.9	13	11	18.4	22	G3/8"	21
EPHF 10-G04	47	35.9	11	14.4	13	18.4	28	G1/2"	24
EPHF 12-G01	29.5	32.5	5.7	9	7	21	14.4	G1/8"	21
EPHF 12-G02	35	33.5	8.3	12	10	21	18.3	G1/4"	21
EPHF 12-G03	41.2	35.6	13.9	13	11	21	22	G3/8"	21
EPHF 12-G04	47	36.6	11	14.4	13	21	28	G1/2"	24

SF-EPB-G

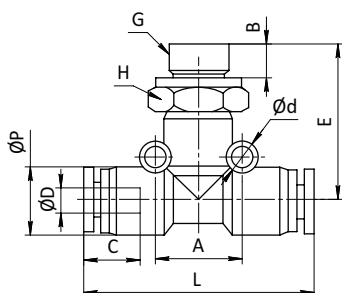

Модель	L	A	B	C	E	Ød	ØD	ØP	H	G
EPB 4-M5	37.4	14	5	15.1	22	3.2	4	11	12	M5
EPB 4-G01	37.4	14	5.5	15.1	25.5	3.2	4	11	14	G1/8"
EPB 4-G02	37.4	14	7.5	15.1	28	3.2	4	11	17	G1/4"
EPB 4-M5	39.2	16	5	16	24	3.2	6	13	12	M5
EPB 6-G01	39.2	16	5.5	16	26	3.2	6	13	14	G1/8"
EPB 6-G02	39.2	16	7.5	16	28.5	3.2	6	13	17	G1/4"
EPB 6-G03	39.2	16	8.5	16	30	3.2	6	13	20	G3/8"
EPB 6-G04	39.2	16	11	16	34	3.2	6	13	24	G1/2"
EPB 8-G01	45.5	18	5.5	18.1	29	3.2	8	14.8	14	G1/8"
EPB 8-G02	45.5	18	7.5	18.1	31.5	3.2	8	14.8	17	G1/4"
EPB 8-G03	45.5	18	8.5	18.1	33	3.2	8	14.8	20	G3/8"
EPB 8-G04	45.5	18	11	18	37	3.2	8	14.8	24	G1/2"
EPB 10-G01	56.3	24	5.5	20.4	34.5	4.2	10	18.4	17	G1/8"
EPB 10-G02	56.3	24	7.5	20.4	36.5	4.2	10	18.4	17	G1/4"
EPB 10-G03	56.3	24	8.5	20.4	38	4.2	10	18.4	20	G3/8"
EPB 10-G04	56.3	24	11	20.4	42	4.2	10	18.4	24	G1/2"
EPB 12-G01	59.2	27	5.5	23.2	36	4.2	12	21	21	G1/8"
EPB 12-G02	59.2	27	7.5	23.2	38	4.2	12	21	21	G1/4"
EPB 12-G03	59.2	27	8.5	23.2	39	4.2	12	21	21	G3/8"
EPB 12-G04	59.2	27	11	23.2	43	4.2	12	21	24	G1/2"
EPB 16-G03	66	31	8.5	24.5	41.5	5.1	16	26	24	G3/8"
EPB 16-G04	66	31	11	24.5	45.5	5.1	16	26	24	G1/2"

SF-EPD-G

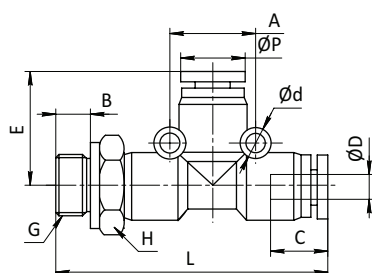

Модель	L	A	B	C	E	Ød	ØD	ØP	H	G
EPD 4-G01	44.2	14	5.5	15.1	18.7	3.2	4	11	14	G1/8"
EPD 4-G02	46.7	14	7.5	15.1	18.7	3.2	4	11	17	G1/4"
EPD 6-G01	45.6	16	5.5	16	19.6	3.2	6	13	14	G1/8"
EPD 6-G02	48.1	16	7.5	16	19.6	3.2	6	13	17	G1/4"
EPD 6-G03	49.6	16	8.5	16	19.6	3.2	6	13	20	G3/8"
EPD 6-G04	53.6	16	11	16	19.6	3.2	6	13	24	G1/2"
EPD 8-G01	51.7	18	5.5	18.1	22.8	3.2	8	14.8	14	G1/8"
EPD 8-G02	54.2	18	7.5	18.1	22.8	3.2	8	14.8	17	G1/4"
EPD 8-G03	55.7	18	8.5	18.1	22.8	3.2	8	14.8	20	G3/8"
EPD 8-G04	59.7	18	11	18.1	22.8	3.2	8	14.8	24	G1/2"
EPD 10-G01	62.8	24	5.5	20.4	28.3	4.2	10	18.4	17	G1/8"
EPD 10-G02	64.8	24	7.5	20.4	28.3	4.2	10	18.4	17	G1/4"
EPD 10-G03	66.3	24	8.5	20.4	28.3	4.2	10	18.4	20	G3/8"
EPD 10-G04	70.3	24	11	20.4	28.3	4.2	10	18.4	24	G1/2"
EPD 12-G01	65.6	27	5.5	23.2	29.6	4.2	12	21	21	G1/8"
EPD 12-G02	67.6	27	7.5	23.2	29.6	4.2	12	21	21	G1/4"
EPD 12-G03	68.6	27	8.5	23.2	29.6	4.2	12	21	21	G3/8"
EPD 12-G04	72.6	27	11	23.2	29.6	4.2	12	21	24	G1/2"
EPD 16-G03	76.5	31	8.5	24.5	33	5.1	16	26	24	G3/8"
EPD 16-G04	80.5	31	11	24.5	33	5.1	16	26	24	G1/2"

Пластиковые фитинги

SF-EPX-G

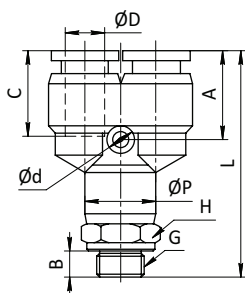

Модель	L	A	B	C	ØP	ØD	H	G	Ød
EPX 4-M5	32	10	4	15.1	11	4	12	M5	3.2
EPX 4-G01	35.5	10	5.5	15.1	11	4	14	G1/8"	3.2
EPX 4-G02	39	10	7.5	15.1	11	4	17	G1/4"	3.2
EPX 6-M5	35	10.5	4	16	13	6	12	M5	3.2
EPX 6-G01	39.2	10.5	5.5	16	13	6	14	G1/8"	3.2
EPX 6-G02	42.2	10.5	7.5	16	13	6	17	G1/4"	3.2
EPX 6-G03	43.7	10.5	8.5	16	13	6	20	G3/8"	3.2
EPX 6-G04	46.2	10.5	11	16	13	6	24	G1/2"	3.2
EPX 8-G01	44.3	13.4	5.5	18.1	14.8	8	14	G1/8"	3.2
EPX 8-G02	46.8	13.4	7.5	18.1	14.8	8	17	G1/4"	3.2
EPX 8-G03	48.4	13.4	8.5	18.1	14.8	8	20	G3/8"	3.2
EPX 8-G04	50.8	13.4	11	18.1	14.8	8	24	G1/2"	3.2
EPX 10-G01	54.3	15.5	5.5	20.4	18.4	10	17	G1/8"	4.2
EPX 10-G02	56.3	15.5	7.5	20.4	18.4	10	17	G1/4"	4.2
EPX 10-G03	57.3	15.5	8.5	20.4	18.4	10	20	G3/8"	4.2
EPX 10-G04	60.8	15.5	11	20.4	18.4	10	24	G1/2"	4.2
EPX 12-G01	61.5	15.5	5.5	23.2	21	12	21	G1/8"	4.2
EPX 12-G02	61.5	15.5	7.5	23.2	21	12	21	G1/4"	4.2
EPX 12-G03	62.5	15.5	8.5	23.2	21	12	21	G3/8"	4.2
EPX 12-G04	65.5	15.5	11	23.2	21	12	24	G1/2"	4.2
EPX 16-G03	70.5	16.5	8.5	24.5	26	16	24	G3/8"	5.1
EPX 16-G04	74.5	16.5	11	24.5	26	16	24	G1/2"	5.1

SF-EPKB-G

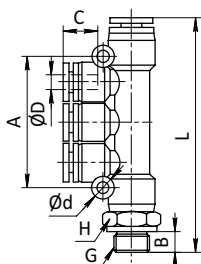

Модель	L	A	B	C	ØD	Ød	H	G
EPKB4-G01	64.2	36	5.5	15.1	4	3.2	14	G1/8"
EPKB4-G02	66.7	36	7.5	15.1	4	3.2	17	G1/4"
EPKB6-G01	68.6	42	5.5	16	6	3.2	14	G1/8"
EPKB6-G02	71	42	7.5	16	6	3.2	17	G1/4"
EPKB6-G03	72.6	42	8.5	16	6	3.2	20	G3/8"
EPKB8-G01	87.8	48	5.5	18.1	8	3.2	14	G1/8"
EPKB8-G02	90.3	48	7.5	18.1	8	3.2	17	G1/4"
EPKB8-G03	91.8	48	8.5	18.1	8	3.2	20	G3/8"

SF-EPKD-G

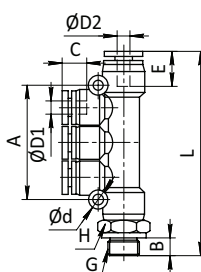

Модель	L	A	B	C	E	D1	D2	D	H	G
EPKD6-4-G01	64.2	36	5.5	16	15.1	6	4	3.2	14	G1/8"
EPKD8-4-G02	70.7	42	7.5	18.1	15.1	8	4	3.2	17	G1/4"
EPKD8-6-G02	71.1	42	7.5	18.1	16	8	6	3.2	17	G1/4"
EPKD10-8-G03	91.8	48	8.5	20.4	18.1	10	8	3.2	20	G3/8"

SF-EPGL-1-G

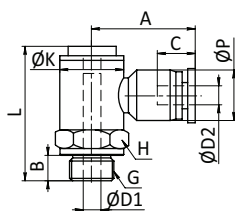

Модель	L	A	C	ØD1	ØD2	H	G	ØK	ØP	B
EPGL4-G01(1)	28	22.7	11.6	6.5	4	14	G1/8"	14	11	5.5
EPGL4-G02(1)	37	24.7	11.6	7.5	4	17	G1/4"	17.8	11	7.5
EPGL4-G03(1)	39.1	26.8	12.2	8.5	6	20	G3/8"	21.9	13	8.5
EPGL6-G01(1)	28	22.1	12.2	6.5	6	14	G1/8"	14	13	5.5
EPGL6-G02(1)	37	24	12.2	7.5	6	17	G1/4"	17.8	13	7.5
EPGL6-G03(1)	39.1	26	12.2	8.5	6	20	G3/8"	21.9	13	8.5
EPGL8-G01(1)	28	24.8	13.2	6.5	8	14	G1/8"	14	14.8	5.5
EPGL8-G02(1)	37	26.8	13.2	7.5	8	17	G1/4"	17.8	14.8	7.5
EPGL8-G03(1)	39.1	28.8	13.2	8.5	8	24	G3/8"	21.9	14.8	8.5
EPGL8-G04(1)	43.1	20.4	13.2	11.5	8	15	G1/2"	27.1	14.8	11
EPGL10-G02(1)	37	30.3	15.2	7.5	10	17	G1/4"	17.8	18.4	7.5
EPGL10-G03(1)	39.1	32.3	15.2	8.5	10	20	G3/8"	21.9	18.4	8.5
EPGL10-G04(1)	43.1	34.4	15.2	11.5	10	24	G1/2"	27.1	18.4	11
EPGL12-G02(1)	37	31.1	17.7	7.5	12	17	G1/4"	17.8	21	7.5
EPGL12-G03(1)	39.1	33.1	17.7	8.5	12	20	G3/8"	21.9	21	8.5
EPGL12-G04(1)	43.1	35.2	17.7	11.5	12	24	G1/2"	27.1	21	11

SF-EPGL-2-G

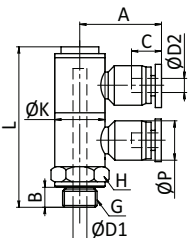

Модель	L	A	C	ØD1	ØD2	H	G	ØK	ØP	B
EPGL4-G01(2)	43.3	22.7	11.6	6.5	4	14	G1/8"	14	11	5.5
EPGL4-G02(2)	58.5	24.7	11.6	7.5	4	17	G1/4"	17.8	11	7.5
EPGL4-G03(2)	60.9	26.8	12.2	8.5	6	20	G3/8"	21.9	13	8.5
EPGL6-G01(2)	43.3	22.1	12.2	6.5	6	14	G1/8"	14	13	5.5
EPGL6-G02(2)	58.5	24.1	12.2	7.5	6	17	G1/4"	17.8	13	7.5
EPGL6-G03(2)	60.9	26.1	12.2	8.5	6	20	G3/8"	21.9	13	8.5
EPGL8-G01(2)	43.3	24.8	13.2	6.5	8	14	G1/8"	14	14.8	5.5
EPGL8-G02(2)	58.5	26.8	13.2	7.5	8	17	G1/4"	17.8	14.8	7.5
EPGL8-G03(2)	60.9	28.8	13.2	8.5	8	24	G3/8"	21.9	14.8	8.5
EPGL8-G04(2)	64.9	20.4	13.2	11.5	8	15	G1/2"	27.1	14.8	11
EPGL10-G02(2)	58.5	30.3	15.2	7.5	10	17	G1/4"	17.8	18.4	7.5
EPGL10-G03(2)	60.9	32.3	15.2	8.5	10	20	G3/8"	21.9	18.4	8.5
EPGL10-G04(2)	64.9	34.4	15.2	11.5	10	24	G1/2"	27.1	18.4	11
EPGL12-G02(2)	58.5	31.1	17.7	7.5	12	17	G1/4"	17.8	21	7.5
EPGL12-G03(2)	60.9	33.1	17.7	8.5	12	20	G3/8"	21.9	21	8.5
EPGL12-G04(2)	64.9	35.2	17.7	11.5	12	24	G1/2"	27.1	21	11

SF-EPGL-3-G

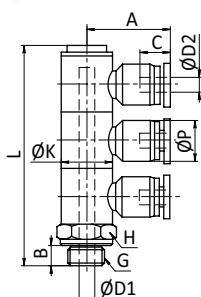

Модель	L	A	C	ØD1	ØD2	H	G	ØK	ØP	B
EPGL4-G01(3)	58.6	22.7	11.6	6.5	4	14	G1/8"	14	11	5.5
EPGL4-G02(3)	80	24.7	11.6	7.5	4	17	G1/4"	17.8	11	7.5
EPGL4-G03(3)	82.1	26.8	12.2	8.5	6	20	G3/8"	21.9	13	8.5
EPGL6-G01(3)	58.6	22.1	12.2	6.5	6	14	G1/8"	14	13	5.5
EPGL6-G02(3)	80	24.1	12.2	7.5	6	17	G1/4"	17.8	13	7.5
EPGL6-G03(3)	82.1	26.1	12.2	8.5	6	20	G3/8"	21.9	13	8.5
EPGL8-G01(3)	58.6	24.8	13.2	6.5	8	14	G1/8"	14	14.8	5.5
EPGL8-G02(3)	80	26.8	13.2	7.5	8	17	G1/4"	17.8	14.8	7.5
EPGL8-G03(3)	82.1	28.8	13.2	8.5	8	24	G3/8"	21.9	14.8	8.5
EPGL8-G04(3)	86.1	20.4	13.2	11.5	8	15	G1/2"	27.1	14.8	11
EPGL10-G02(3)	80	30.3	15.2	7.5	10	17	G1/4"	17.8	18.4	7.5
EPGL10-G03(3)	82.1	32.3	15.2	8.5	10	20	G3/8"	21.9	18.4	8.5
EPGL10-G04(3)	86.1	34.4	15.2	11.5	10	24	G1/2"	27.1	18.4	11
EPGL12-G02(3)	80	31.1	17.7	7.5	12	17	G1/4"	17.8	21	7.5
EPGL12-G03(3)	82.1	33.1	17.7	8.5	12	20	G3/8"	21.9	21	8.5
EPGL12-G04(3)	86.1	35.2	17.7	11.5	12	24	G1/2"	27.1	21	11

Пластиковые фитинги

SF-EPGT-1-G

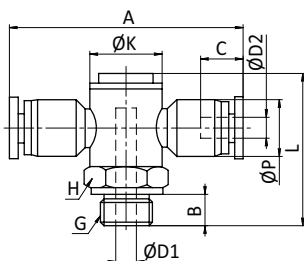

Модель	L	A	C	ØD1	ØD2	H	G	ØK	ØP	B
EPGT4-G01(1)	28	45.4	11.6	6	4	14	G1/8"	14	11	5.5
EPGT4-G02(1)	37	49.4	11.6	8.3	4	17	G1/4"	17.8	11	7.5
EPGT6-G01(1)	28	44.2	12.2	6	6	14	G1/8"	14	13	5.5
EPGT6-G02(1)	37	48.2	12.2	8.5	6	17	G1/4"	17.8	13	7.5
EPGT8-G01(1)	28	49.8	13.2	6	8	14	G1/8"	14	14.8	5.5
EPGT8-G02(1)	37	53.8	13.2	8.5	8	17	G1/4"	17.8	14.8	7.5
EPGT8-G03(1)	39.1	57.8	13.2	11.5	8	20	G3/8"	21.9	14.8	8.5
EPGT10-G02(1)	37	60.3	15.2	8.5	10	17	G1/4"	17.8	18.4	7.5
EPGT10-G03(1)	39.1	64.3	15.2	11.5	10	20	G3/8"	21.9	18.4	8.5
EPGT12-G02(1)	37	62.2	17.7	8.5	12	17	G1/4"	17.8	21	7.5
EPGT12-G03(1)	39.1	66.2	17.7	11.5	12	20	G3/8"	21.9	21	8.5
EPGT12-G04(1)	43.1	71.4	17.7	15.8	12	24	G1/2"	27.1	21	11

SF-EPGT-2-G

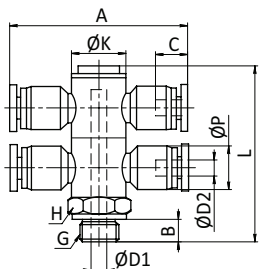

Модель	L	A	C	ØD1	ØD2	H	G	ØK	ØP	B
EPGT4-G01(2)	43.3	45.4	11.6	6	4	14	G1/8"	14	11	5.5
EPGT4-G02(2)	58.5	49.4	11.6	8.3	4	17	G1/4"	17.8	11	7.5
EPGT6-G01(2)	43.3	44.2	12.2	6	6	14	G1/8"	14	13	5.5
EPGT6-G02(2)	58.5	48.2	12.2	8.5	6	17	G1/4"	17.8	13	7.5
EPGT8-G01(2)	43.3	49.8	13.2	6	8	14	G1/8"	14	14.8	5.5
EPGT8-G02(2)	58.5	53.8	13.2	8.5	8	17	G1/4"	17.8	14.8	7.5
EPGT8-G03(2)	60.9	57.8	13.2	11.5	8	20	G3/8"	21.9	14.8	8.5
EPGT10-G02(2)	58.5	60.3	15.2	8.5	10	17	G1/4"	17.8	18.4	7.5
EPGT10-G03(2)	60.9	64.3	15.2	11.5	10	20	G3/8"	21.9	18.4	8.5
EPGT12-G02(2)	58.5	62.2	17.7	8.5	12	17	G1/4"	17.8	21	7.5
EPGT12-G03(2)	60.9	66.2	17.7	11.5	12	20	G3/8"	21.9	21	8.5
EPGT12-G04(2)	64.9	71.4	17.7	15.8	12	24	G1/2"	27.1	21	11

SF-EPGT-3-G

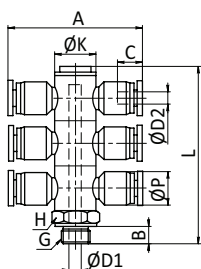

Модель	L	A	C	ØD1	ØD2	H	G	ØK	ØP	B
EPGT4-G01(3)	58.6	45.4	11.6	6	4	14	G1/8"	14	11	5.5
EPGT4-G02(3)	80	49.4	11.6	8.3	4	17	G1/4"	17.8	11	7.5
EPGT6-G01(3)	58.6	44.2	12.2	6	6	14	G1/8"	14	13	5.5
EPGT6-G02(3)	80	48.2	12.2	8.5	6	17	G1/4"	17.8	13	7.5
EPGT8-G01(3)	58.6	49.8	13.2	6	8	14	G1/8"	14	14.8	5.5
EPGT8-G02(3)	80	53.8	13.2	8.5	8	17	G1/4"	17.8	14.8	7.5
EPGT8-G03(3)	82.1	57.8	13.2	11.5	8	20	G3/8"	21.9	14.8	8.5
EPGT10-G02(3)	80	60.3	15.2	8.5	10	17	G1/4"	17.8	18.4	7.5
EPGT10-G03(3)	82.1	64.3	15.2	11.5	10	20	G3/8"	21.9	18.4	8.5
EPGT12-G02(3)	80	62.2	17.7	8.5	12	17	G1/4"	17.8	21	7.5
EPGT12-G03(3)	82.1	66.2	17.7	11.5	12	20	G3/8"	21.9	21	8.5
EPGT12-G04(3)	86.1	71.4	17.7	15.8	12	24	G1/2"	27.1	21	11

Пластиковые фитинги с накладной гайкой

■ SF-CFCK

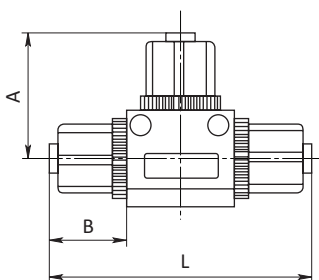

Модель	L	A	B	Трубка
SF-CFCK 06	46	22.5	13.5	6
SF-CFCK 08	48	24	14	8

■ SF-CK

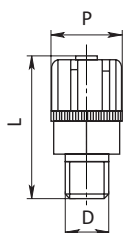

Модель	L	D	P	Трубка
SF-CK 06-01	32.5	1/8	15	6
SF-CK 06-02	32.5	1/4	15	6
SF-CK 08-01	32.5	1/8	15	8
SF-CK 08-02	32.5	1/4	15	8

■ SF-CGCK

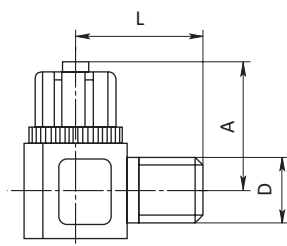

Модель	L	D	A	Трубка
SF-CGCK 06-01	23.5	1/8	23	6
SF-CGCK 06-02	24	1/4	24	6
SF-CGCK 08-01	23.5	1/8	23	8
SF-CGCK 08-02	24	1/4	24	8

Вентили

SF-EHVFF

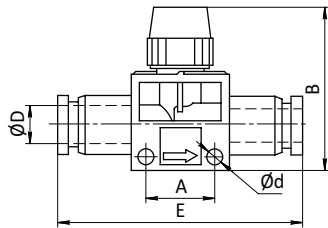

Модель		D	d	A	B	E
2/2	3/2					
EHVFF06-06B	EHVFF06-06	6	4.2	16.5	41.5	51.6
EHVFF08-06B	EHVFF08-06	6	4.2	16.5	41.5	52.1
EHVFF08-08B	EHVFF08-08	8	4.2	16.5	41.5	52.6
EHVFF10-10B	EHVFF10-10	10	4.2	21.5	46	64.1
EHVFF12-10B	EHVFF12-10	12	4.2	21.5	46	64.4
EHVFF12-12B	EHVFF12-12	12	4.2	21.5	46	64.7

SF-EHVSF-G

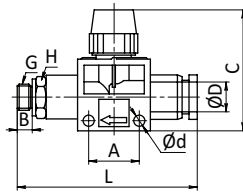

Модель		L	A	B	C	ØD	Ød	G	H
2/2	3/2								
EHVSF G01-06B	EHVSF G01-06	58.3	16.5	5.5	41.5	6	4.2	G1/8"	14
EHVSF G02-06B	EHVSF G02-06	60.8	16.5	7.5	41.5	6	4.2	G1/4"	17
EHVSF G03-06B	EHVSF G03-06	62.3	16.5	8.5	41.5	6	4.2	G3/8"	20
EHVSF G01-08B	EHVSF G01-08	58.8	16.5	5.5	41.5	8	4.2	G1/8"	14
EHVSF G02-08B	EHVSF G02-08	61.3	16.5	7.5	41.5	8	4.2	G1/4"	17
EHVSF G03-08B	EHVSF G03-08	62.8	16.5	8.5	41.5	8	4.2	G3/8"	20
EHVSF G02-10B	EHVSF G02-10	72.3	21.5	7.5	46	10	4.2	G1/4"	17
EHVSF G03-10B	EHVSF G03-10	73.8	21.5	8.5	46	10	4.2	G3/8"	20
EHVSF G04-10B	EHVSF G04-10	77.8	21.5	11	46	10	4.2	G1/2"	24
EHVSF G02-12B	EHVSF G02-12	73.1	21.5	7.5	46	12	4.2	G1/4"	21
EHVSF G03-12B	EHVSF G03-12	74.1	21.5	8.5	46	12	4.2	G3/8"	20
EHVSF G04-12B	EHVSF G04-12	78.1	21.5	11	46	12	4.2	G1/2"	24

SF-EHVSF-G

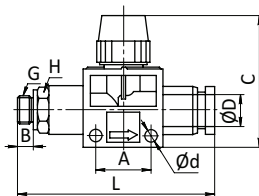

Модель		L	A	B	C	ØD	Ød	G	H
2/2	3/2								
EHVSF06-G01B	EHVSF06-G01	58.3	16.5	5.5	41.5	6	4.2	G1/8"	14
EHVSF06-G02B	EHVSF06-G02	60.8	16.5	7.5	41.5	6	4.2	G1/4"	17
EHVSF06-G03B	EHVSF06-G03	62.3	16.5	8.5	41.5	6	4.2	G3/8"	20
EHVSF08-G01B	EHVSF08-G01	58.8	16.5	5.5	41.5	8	4.2	G1/8"	14
EHVSF08-G02B	EHVSF08-G02	61.3	16.5	7.5	41.5	8	4.2	G1/4"	17
EHVSF08-G03B	EHVSF08-G03	62.8	16.5	8.5	41.5	8	4.2	G3/8"	20
EHVSF10-G02B	EHVSF10-G02	72.3	21.5	7.5	46	10	4.2	G1/4"	17
EHVSF10-G03B	EHVSF10-G03	73.8	21.5	8.5	46	10	4.2	G3/8"	20
EHVSF10-G04B	EHVSF10-G04	77.8	21.5	11	46	10	4.2	G1/2"	24
EHVSF12-G02B	EHVSF12-G02	73.1	21.5	7.5	46	12	4.2	G1/4"	21
EHVSF12-G03B	EHVSF12-G03	74.1	21.5	8.5	46	12	4.2	G3/8"	20
EHVSF12-G04B	EHVSF12-G04	78.1	21.5	11	46	12	4.2	G1/2"	24

SF-EHVSS-G

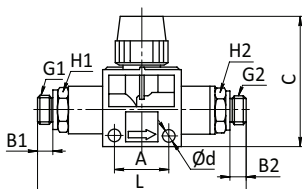

Модель		L	A	B1	B2	C	d	G1	G2	H1	H2
2/2	3/2										
EHVSS G01-G01B	EHVSS G01-G01	66	16.5	5.5	5.5	41.5	4.2	G1/8"	G1/8"	14	14
EHVSS G02-G01B	EHVSS G02-G01	68.5	16.5	7.5	5.5	41.5	4.2	G1/4"	G1/8"	17	14
EHVSS G02-G02B	EHVSS G02-G02	71	16.5	7.5	7.5	41.5	4.2	G1/4"	G1/4"	17	17
EHVSS G03-G02B	EHVSS G03-G02	82.5	21.5	8.5	7.5	46	4.2	G3/8"	G1/4"	17	17
EHVSS G03-G03B	EHVSS G03-G03	83.5	21.5	8.5	8.5	46	4.2	G3/8"	G3/8"	17	17
EHVSS G04-G03B	EHVSS G04-G03	83	21.5	11	8.5	46	4.2	G1/2"	G3/8"	21	21
EHVSS G04-G04B	EHVSS G04-G04	91.5	21.5	11	11	46	4.2	G1/2"	G1/2"	21	21

Глушители

Используются для снижения уровня шума при выхлопе воздуха из распределителя.

BSL

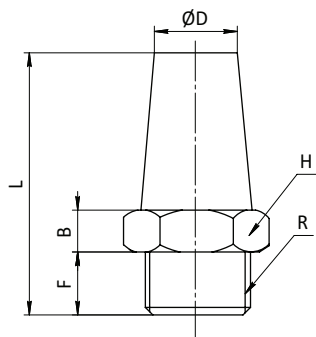

Модель	R	ØD	B	F	L	S
BSL-M5	M5	5.5	3.5	5	20	10
BSL-01	R1/8	8	4	6	24	13
BSL-02	R1/4	11	4	8	33	17
BSL-03	R3/8	14	5	10	44	22
BSL-04	R1/2	18	6.5	10	49	24
BSL-06	R3/4	21	7.5	11	57	30
BSL-10	R1	27	8.5	15.5	72	36
BSL-12	R1-1/4	32	8	15	77	46
BSL-14	R1-1/2	38	8.5	15	83	52
BSL-20	R2	50	9	17	5	64

BSLM

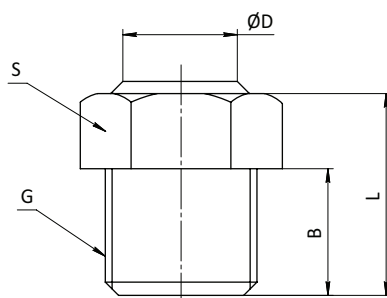

Модель	G	B	L	S	ØD
BSLM-01	G1/8	6	11	12	10
BSLM-02	G1/4	8.5	14.5	16	13
BSLM-03	G3/8	10	17	19	16
BSLM-04	G1/2	11	19	22	17
BSLM-06	G3/4	11.5	19.5	27	22
BSLM-10	G1	12.5	20.5	34	30

PUL

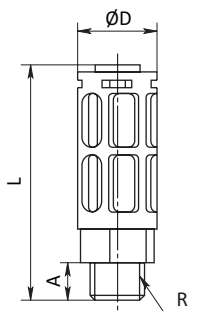

Модель	L	A	ØD	R
PUL-01	40	6	15.8	R1/8"
PUL-02	65	11	20.8	R1/4"
PUL-03	84	12	25	R3/8"
PUL-04	94	14	30	R1/2"

BESLD

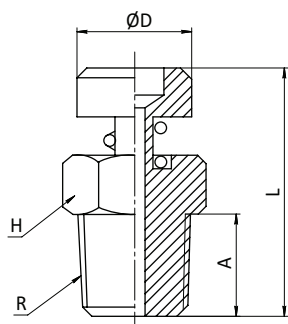

Модель	L	A	ФD	R	H
BESLD 01	25	6	12	R1/8"	17
BESLD 02	30.5	8.5	14	R1/4"	19
BESLD 03	34	10	17	R3/8"	22
BESLD 04	35	11	20	R1/2"	27
BESLD 06	37.5	11.5	25	R3/4"	30
BESLD 08	40.5	12.5	30	R1"	36